

MODELLO: COSMOPOLITAN
 ARTICOLO: 15.39-15.40-15.41

	LAC sp.19	CRIST sp.4	SUPER ARMO sp.5	CEMENTO sp.6	CERAMICA sp.3
L-Larghezza Totale	1238	1240	1242	1244	1238
P-Profondità	550	548	549	550	547
PCS-Profondità con schienale	550	552	554	556	550
H-Altezza	1183	1185	1182	1183	1186
SP-Spessore anta / frontale cassetto	19	20	21	22	19
ST-Spessore Top	6	8	5	6	9

le misure sono espresse in mm

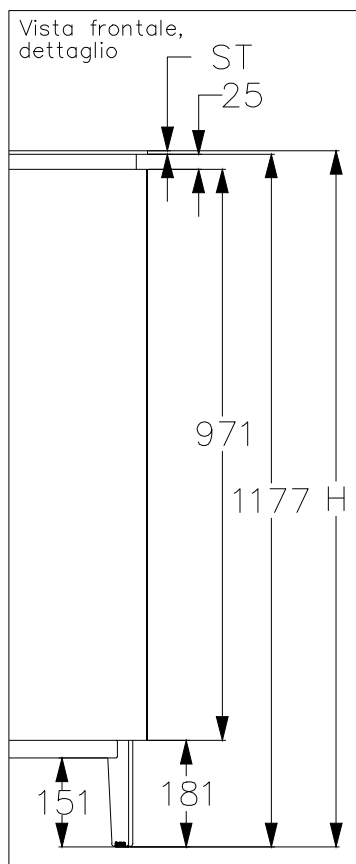

Detta.Anta/Fianco
Versione laccata

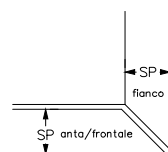

Detta.Anta/Fianco
Altre versioni

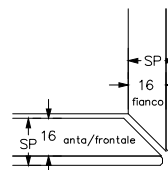

15.39

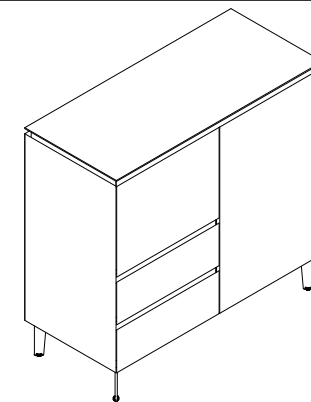
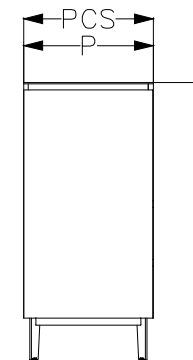
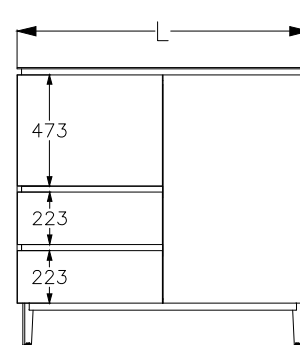

15.40

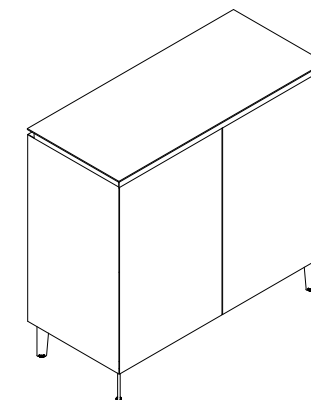
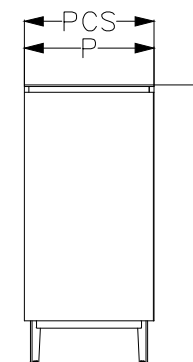
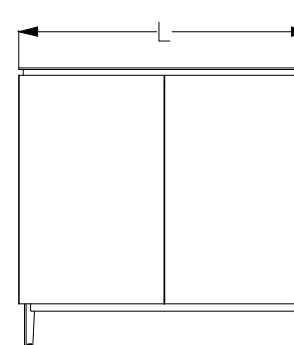

15.41

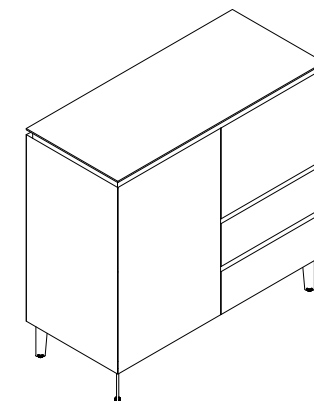
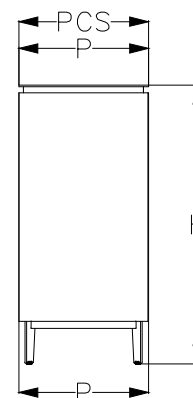

N° DIS.: C273_303

DATA: 06-Dic-16

DISEGNATORE: CARPINETI E.

REV.: -

DATA: -

MODIFICA: -

APPROVATO:
Uff. TECNICO

REV.: -

DATA: -

MODIFICA: -



MODELLO: COSMOPOLITAN					
ARTICOLO: 15.32/15.33/15.34/15.35/15.36/15.37/15.38					
	LAC sp.19	CRIST sp.4	SUPERMARMO sp.5	CEMENTO sp.6	CERAMICA sp.3
L-Larghezza Totale	2438	2440	2442	2444	2438
H-Altezza	685	687	684	685	688
SP-Spessore anta / frontale cassetto	19	20	21	22	19
ST-Spessore Top	6	8	5	6	9

P-Profondità	LAC sp.19	CRIST sp.4	SUPERMARMO sp.5	CEMENTO sp.6	CERAMICA sp.3
15.32-15.36-15.37-15.38	550	548	549	550	547
15.33-15.34-15.35	570	567	567	567	567

PCS-Profondità con schienale	LAC sp.19	CRIST sp.4	SUPERMARMO sp.5	CEMENTO sp.6	CERAMICA sp.3
15.32-15.36-15.37-15.38	550	552	554	556	550
15.33-15.34-15.35	570	571	572	573	570

le misure sono espresse in mm

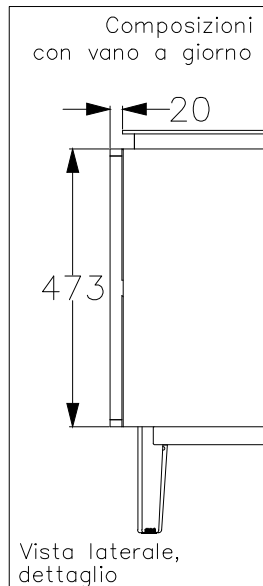
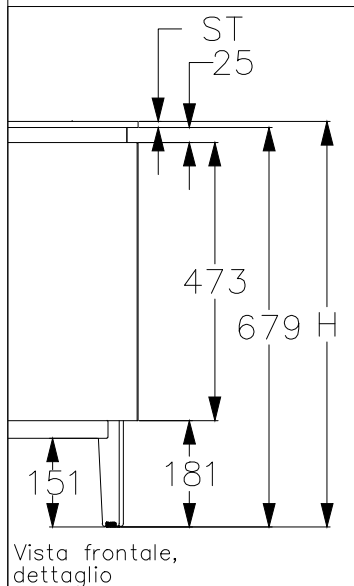

Dett.Anta/Fianco
Versione laccata

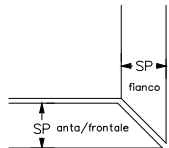

Dett.Anta/Fianco
Altre versioni

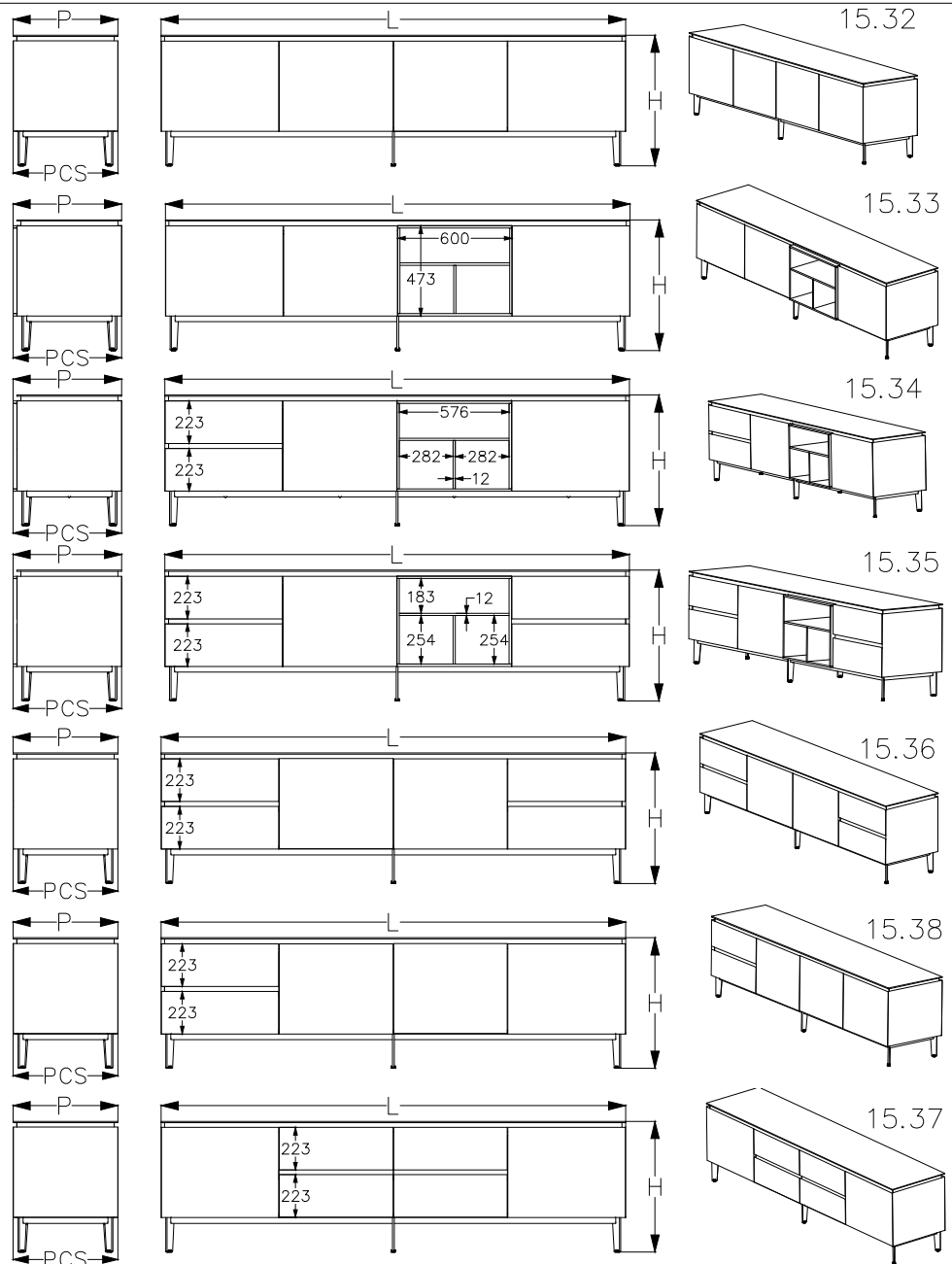
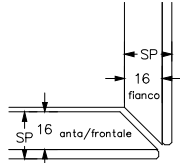

N° DIS.: C273_302

DATA: 06-Dic-16

DISEGNATORE: CARPINETI E.

REV.: -

DATA: -

MODIFICA: -

APPROVATO:
Uff. TECNICO

REV.: -

DATA: -

MODIFICA: -

BONTEMPI
CASA

MODELLO: COSMOPOLITAN
 ARTICOLO: 15.27/15.28/15.29/15.30/15.31

	LAC sp.19	CRIST sp.4	SUPER ARMO sp.5	CEMENTO sp.6	CERAMICA sp.3
L-Larghezza Totale	1838	1840	1842	1844	1838
H-Altezza	685	687	684	685	688
SP-Spessore anta / frontale cassetto	19	20	21	22	19
ST-Spessore Top	6	8	5	6	9

P-Profondità	LAC sp.19	CRIST sp.4	SUPER ARMO sp.5	CEMENTO sp.6	CERAMICA sp.3
15.27-15.29	550	548	549	550	547
15.28-15.30-15.31	570	567	567	567	567

PCS-Profondità con schienale	LAC sp.19	CRIST sp.4	SUPER ARMO sp.5	CEMENTO sp.6	CERAMICA sp.3
15.27-15.29	550	552	554	556	550
15.28-15.30-15.31	570	571	572	573	570

le misure sono espresse in mm

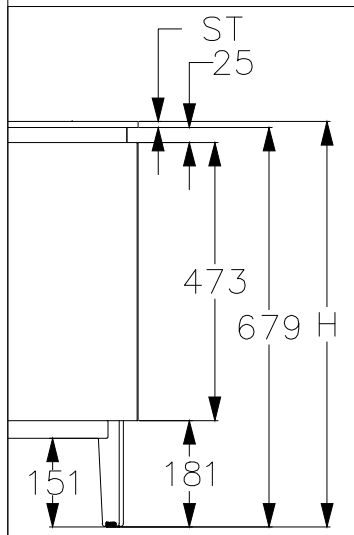

Vista frontale,
dettaglio

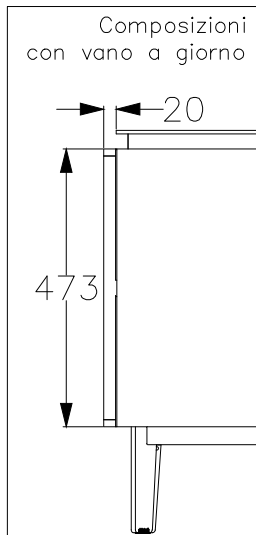

Vista laterale,
dettaglio

Dett.Anta/Fianco
Versione laccata

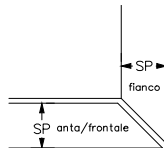

Dett.Anta/Fianco
Altre versioni

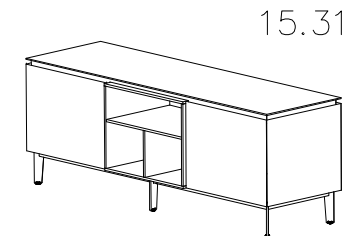
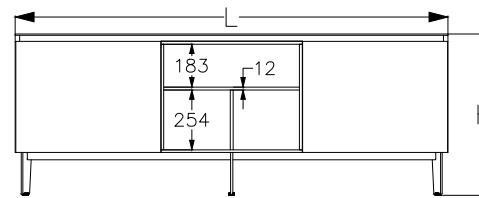
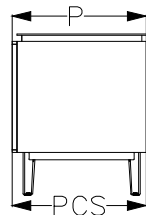
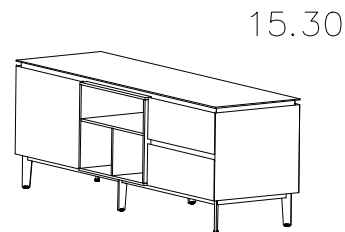
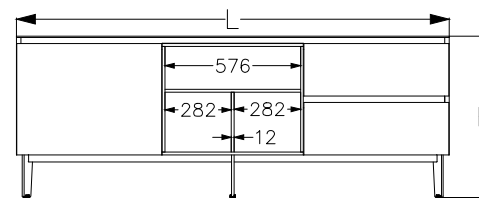
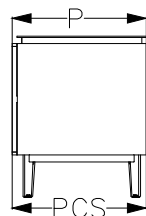
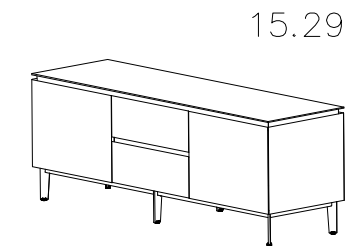
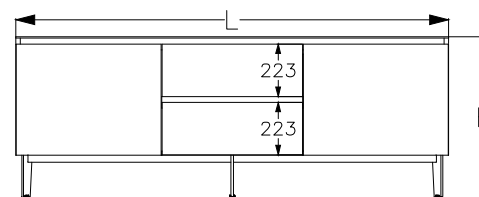
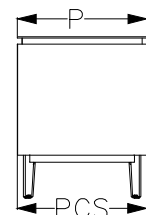
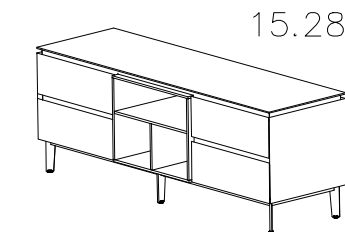
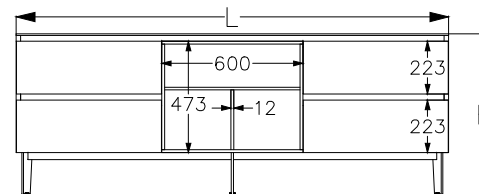
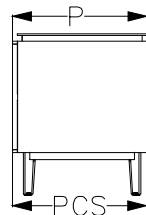
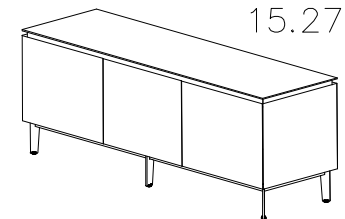
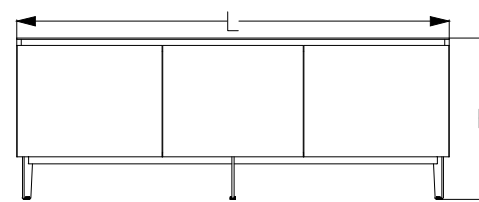
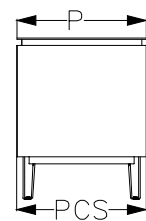
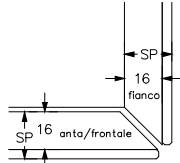

N° DIS.: C273_301

DATA: 06-Dic-16

DISEGNATORE: CARPINETI E.

REV.: -

DATA: -

MODIFICA: -

APPROVATO:
Uff. TECNICO

REV.: -

DATA: -

MODIFICA: -



MODELLO: COSMOPOLITAN
 ARTICOLO: 15.25 / 15.26

	LAC sp.19	CRIST sp.4	SUPERMARMO sp.5	CEMENTO sp.6	CERAMICA sp.3
L-Larghezza Totale	1238	1240	1242	1244	1238
P-Profondità	550	548	549	550	547
PCS-Profondità con schienale	550	552	554	556	550
H-Altezza	685	687	684	685	688
SP-Spessore anta / frontale cassetto	19	20	21	22	19
ST-Spessore Top	6	8	5	6	9

le misure sono espresse in mm

15.25

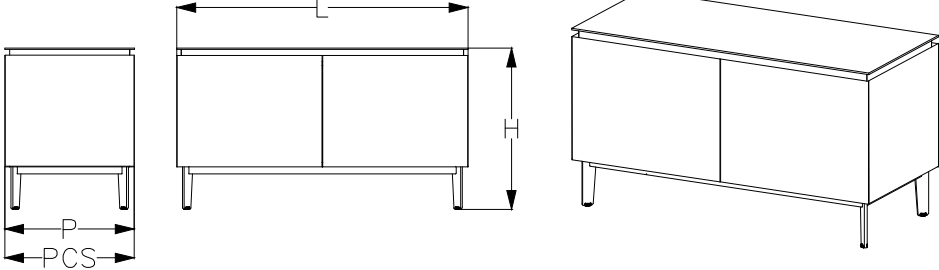

15.26

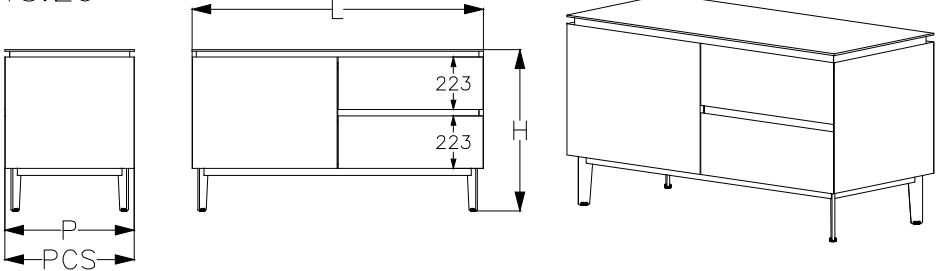

Dett.Anta/Fianco
Versione laccata

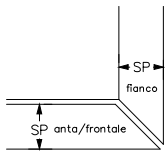

Dett.Anta/Fianco
Altre versioni

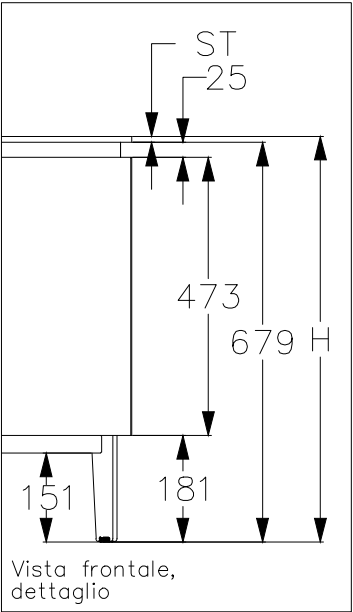
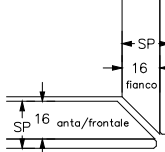

Vista frontale,
dettaglio

N° DIS.: C273_300	DATA: 06-Dic-16	DISEGNATORE: CARPINETI E.	APPROVATO: Uff. TECNICO	BONTEMPI CASA
REV.: -	DATA: -	MODIFICA: -		
REV.: -	DATA: -	MODIFICA: -		